

Gibson® Bell 3 hole truss rod cover

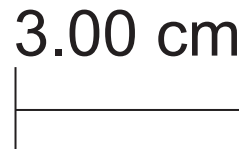
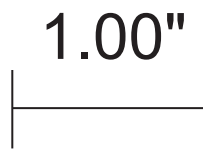
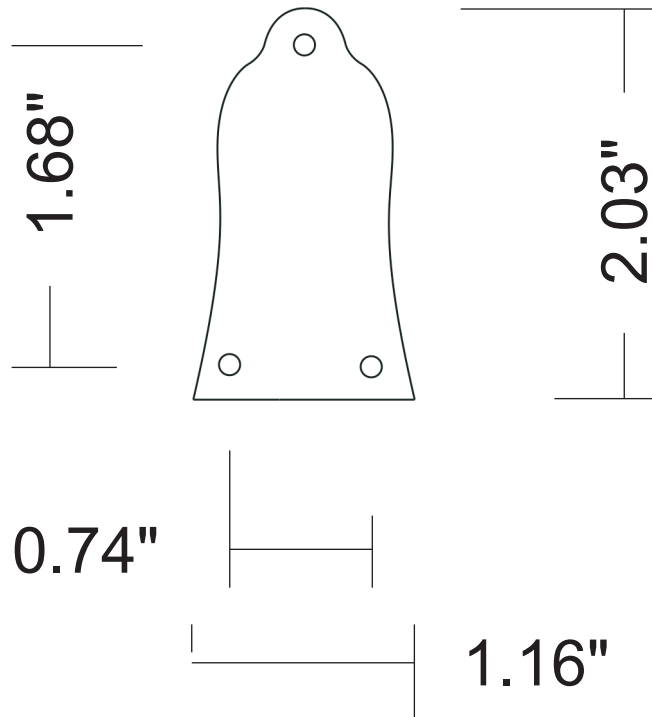

Be sure print scaling is turned off when printing this PDF. After printing be sure and confirm that the dimension lines above are true to scale. If you experience problems with the PDF send a Self Addressed Stamped envelope with your written request for a tracing or print of the template we have on file to: Terrapin Guitars LLC, PO Box 11565, Eugene, OR 97440